

Profile 3035

Ref. A18039

Ref. arch 18039

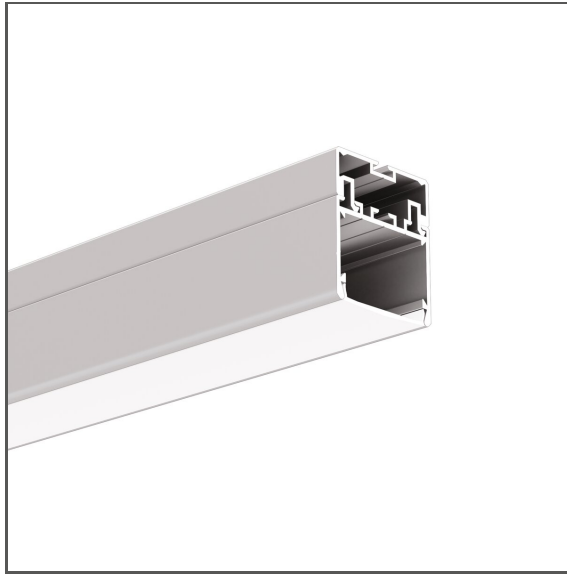

- Easy maintenance
- Wide range of accessories
- Cable management space

APPLICATION

- main lighting

MOUNTING

- suspended or to the surface, using a dedicated mounting track, dedicated accessories or properly selected screws
- can be easily connected into runs and systems

ADDITIONAL INFORMATION

- standard lengths of KLUŚ profiles and covers: 1000 mm (tolerance ± 1.5 mm) and 2005 mm / 3010 mm (tolerance + 5 mm); for selected covers: 6050 mm, 10050 mm (tolerance + 5 mm)
- when choosing a different length of profiles / covers than available in the standard, you should additionally choose the cutting service at KLUŚ

TECHNICAL DRAWING

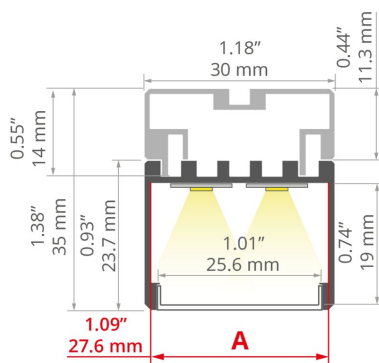

TECHNICAL SPECIFICATIONS

Material	aluminum
Color	■ silver anodized
Possible fixture IP	20
Possible fixture shapes	linear, polygonal
Profile cross-section	rectangular
Width	30 mm
Height	35 mm
LED gluing width A	27.6 mm
Number of LED strips A (8 mm wide)	3
Possibility of obtaining a line of light	yes
Building type	Commercial, Retail, Entertainment/ Arts, HoReCa object
Facility zone	office, communication routes and corridors, conference room, lobby / foyer
The cover is cut to the length of the profile	yes
Can be easily connected into runs	yes
Wire out back of extrusion	yes

Length	Ref
1000 mm	A18039A_1 18039ANODA_1
2005 mm	A18039A_2 18039ANODA_2
3010 mm	A18039A_3 18039ANODA_3

Profile 3035

Ref. A18039

Ref. arch 18039

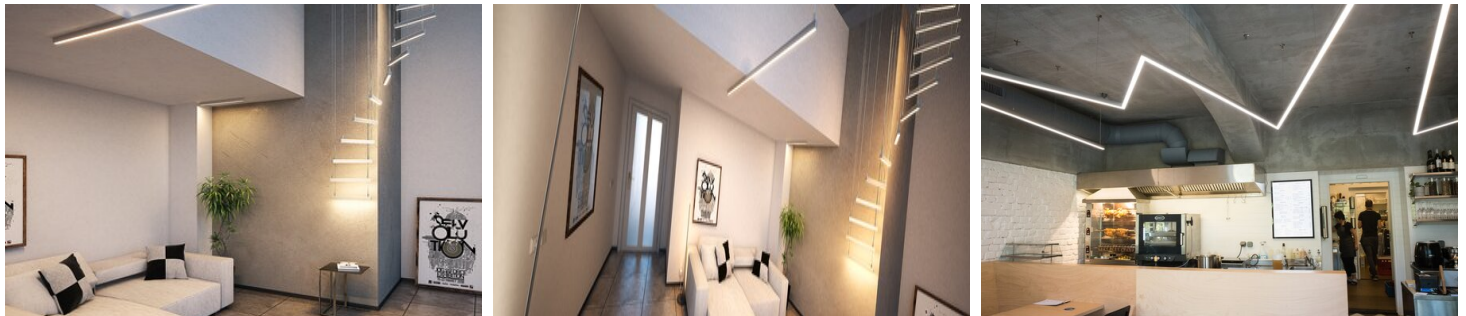

SAMPLE PROJECTS



RELATED ACCESSORIES > RELATED COVERS

NAME	MATERIAL	MATERIAL TRANSMITTANCE	COLOR	REF.
3035	 PC	62 %	<input type="checkbox"/> frosted	B17141M 17141

RELATED ACCESSORIES > RELATED END CAPS

NAME	MATERIAL	COLOR	REF.
3035	 ABS	<input checked="" type="checkbox"/> gray	C24273C02 24273
3035-HQ	 aluminum	<input checked="" type="checkbox"/> gray	C28216AS 42624

RELATED ACCESSORIES > RELATED LED

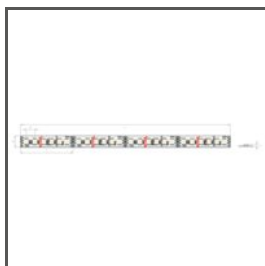

K-0700-120-RGB-24V

_bład
Ref. arch K-0700-120-RGB-24V

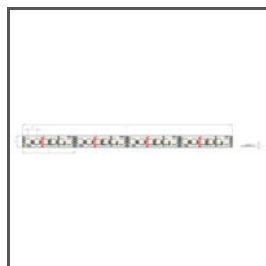

K-1200-120-RGB-24V

_bład
Ref. arch K-1200-120-RGB-24V

RELATED ACCESSORIES > RELATED LED > BENDABLE



K-BT-RGB40-1510-24V

K-BTRGB40-1510-24

Ref. arch K-BT-RGB40-1510-24V

RELATED ACCESSORIES > RELATED LED > CRI 95+

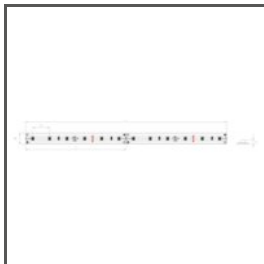

K-CR-1210-24V

K-CR-1210-24

Ref. arch K-CR-1210-24V

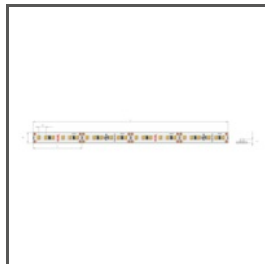

K-CR-1220-24V

K-CR-1220-24

Ref. arch K-CR-1220-24V

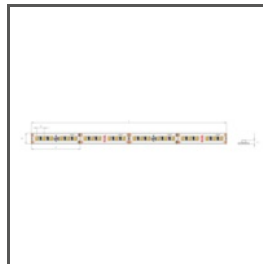

K-CR-1275-24V

K-CR-1275-24

Ref. arch K-CR-1275-24V

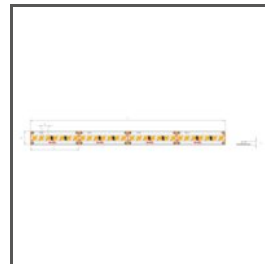

K-CR-1820-HD-24V

K-CRHD-1820-24

Ref. arch K-CR-1820-HD-24V

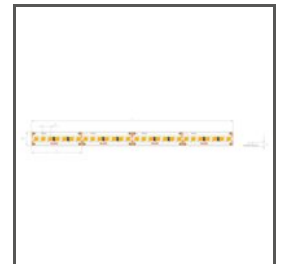

K-CR-1910-HD-24V

K-CRHD-1910-24

Ref. arch K-CR-1910-HD-24V

RELATED ACCESSORIES > RELATED LED > DIM TO WARM



K-27/50-1440-24V

K-27/50-1440-24

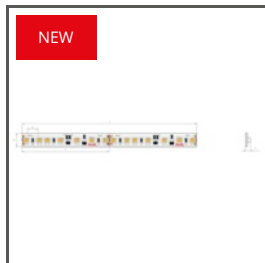

K-18/30-0960-24V

K-18/30-0960-24

Ref. arch K-30/18-0960-24V

RELATED ACCESSORIES > RELATED LED > HIGH EFFICACY

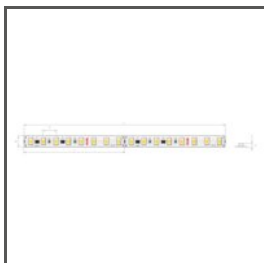

K-HE-0480-HD-24V

K-HEHD-0480-24

Ref. arch K-HE-0480-HD-24V

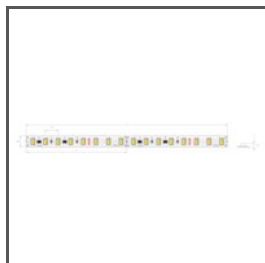

K-HE-0960-HD-24V

K-HEHD-0960-24

Ref. arch K-HE-0960-HD-24V

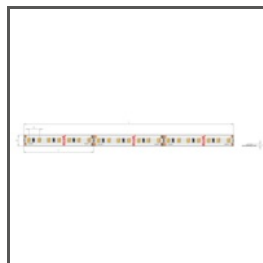

K-HE-1440-HD-24V

K-HEHD-1440-24

Ref. arch K-HE-1440-HD-24V

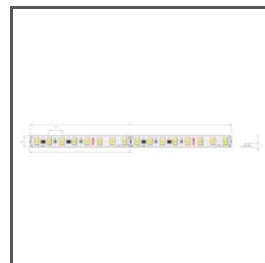

K-HE-1920-HD-24V

K-HEHD-1920-24

Ref. arch K-HE-1920-HD-24V

Profile 3035

Ref. A18039

Ref. arch 18039

RELATED ACCESSORIES > RELATED LED > RGB / RGB-W / RGB-CTT

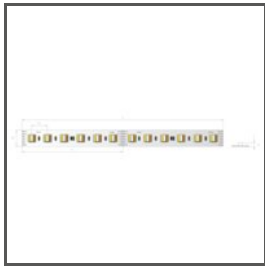

K-1200-RGB+27/65-24V

K-RGB27/65-1200-24

Ref. arch K-1200-RGB+27/65-24V



K-1530-RGB+W-24V

K-RGBW-1530-24

Ref. arch K-1530-RGB+W-24V

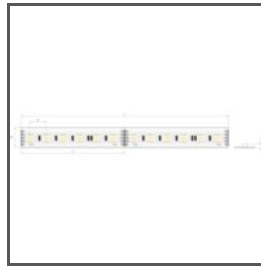

K-1920-120-RGB-24V

K-RGB-1920-120-24

Ref. arch K-1920-120-RGB-24V



NEW

K-RGB-1200-24V

K-RGB-1200-24

Ref. arch K-RGB-1200-24V



NEW

K-RGB-0700-24V

K-RGB-700-24V

Ref. arch K-RGB-0700-24V

RELATED ACCESSORIES > RELATED LED > WHITE MONO



K-0530-HD-24V

K-HD-0530-24

Ref. arch K-0530-HD-24V

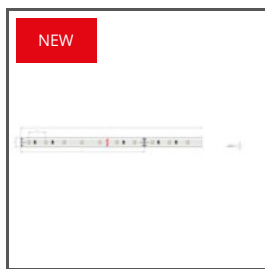

NEW

K-0480-24V

K-0480-24

Ref. arch K-0480-24V



NEW

K-0960-24V

K-0960-24

Ref. arch K-0960-24V

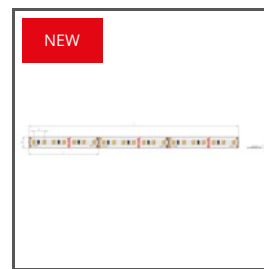

NEW

K-1440-24V

K-1440-24

Ref. arch K-1440-24V



NEW

K-2400-24

K-2400-24

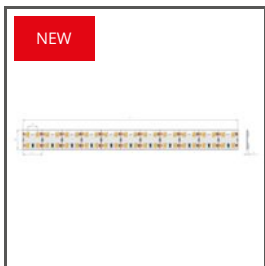

NEW

K2-1920-24

K2-1920-24



NEW

K3-2880-24

K3-2880-24

RELATED ACCESSORIES > OTHER RELATED ACCESSORIES > ADDITIONAL ITEMS



CANOPY

Fi-60mm

C24540

RELATED ACCESSORIES > OTHER RELATED ACCESSORIES > CONDUCTIVE FASTENERS AND HEADS FOR PROFILES



FASTENER
FI-8-LIN-ZMZ
C28171N00, C28171L10,
C28171L07
Ref. arch 42286, 42286L9010,
42286L9005



FASTENER
PUSZ-LIN-ZM
C28160N00, C28160L10,
C28160L07
Ref. arch 42275, 42275L9010,
42275L9005



FASTENER
PUSZ-LIN-MR
C28163N00, C28163L10,
C28163L07
Ref. arch 42278, 42278L9010,
42278L9005



FASTENER
PUSZ-PRET-ZM
C28161N00, C28161L10,
C28161L07
Ref. arch 42276, 42276L9010,
42276L9005



FASTENER
PUSZ-PRET-LEB
C28165N00, C28165L10,
C28165L07
Ref. arch 42280, 42280L9010,
42280L9005

RELATED ACCESSORIES > OTHER RELATED ACCESSORIES > CONNECTORS



CONNECTOR
ZM-180
C28075N00
Ref. arch 40693



CONNECTOR
ZM-60
C28243N00
Ref. arch 42736

RELATED ACCESSORIES > OTHER RELATED ACCESSORIES > FASTENERS AND HEADS FOR PROFILES



HEAD
BZP
C28113N00
Ref. arch 42213

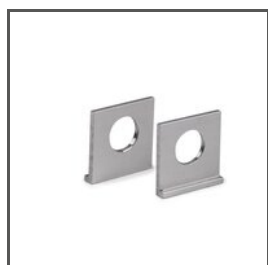

FASTENER
UCHO-ZM
C28192N00, C28192L07
Ref. arch 42512, 42525



FASTENER
FI-10-ZM-P
C28117N00
Ref. arch 42244



FASTENER
FI-10-ZM-W
C28116N00
Ref. arch 42242

RELATED ACCESSORIES > OTHER RELATED ACCESSORIES > ISOLATING BASES

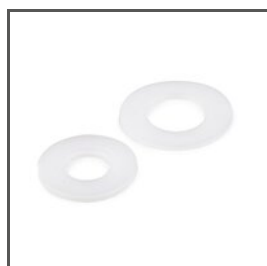

ISOLATING BASES
ARMSTRONG
C28241C10
Ref. arch 42712

RELATED ACCESSORIES > OTHER RELATED ACCESSORIES > OTHER



GLAND

6,4x3

C42264C07

Ref. arch 42264

RELATED ACCESSORIES > OTHER RELATED ACCESSORIES > SECURITY AND BLOCKS

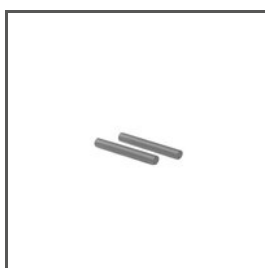

BLOCK

ZM

C28194N00

Ref. arch 42520

RELATED ACCESSORIES > OTHER RELATED ACCESSORIES > SPRINGS FOR RECESSED MOUNT AND MOUNTING TRACKS

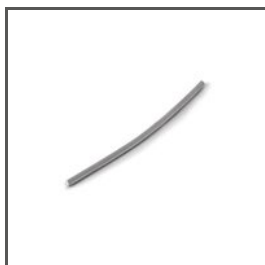

SPRING

BLOK

C42731N00

Ref. arch 42731

RELATED ACCESSORIES > OTHER RELATED ACCESSORIES > SURFACE SPRINGS

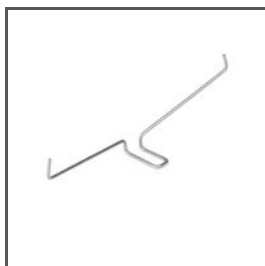

SPRING

GP

C24500N00

Ref. arch 00293

Profile 3035

Ref. A18039

Ref. arch 18039

RELATED ACCESSORIES > OTHER RELATED ACCESSORIES > SUSPENSION AND MOUNTING SETS



FASTENER SET

RG-1

C28230P00, C28230P01,
C28230L10, C28230L07
Ref. arch 42647NI, 42647GSS,
42647L9010, 42647L9005



FASTENER SET

RD-1

C28231
Ref. arch 42658NI, 42658GSS,
42658L9005, 42658L9010



FASTENER SET

RD-2

C28232P00, C28232P01,
C28232L10, C28232L07
Ref. arch 42653NI, 42653GSS,
42653L9010, 42653L9005



FASTENER SET

RD-3

C28233P00, C28233P01,
C28233L10, C28233L07
Ref. arch 42659NI, 42659GSS,
42659L9010, 42659L9005



FASTENER SET

RD-4

C28234P00, C28234P01,
C28234L10, C28234L07
Ref. arch 42657NI, 42657GSS,
42657L9010, 42657L9005