

Profile STEPUS

Ref. A18038

Ref. arch 18038

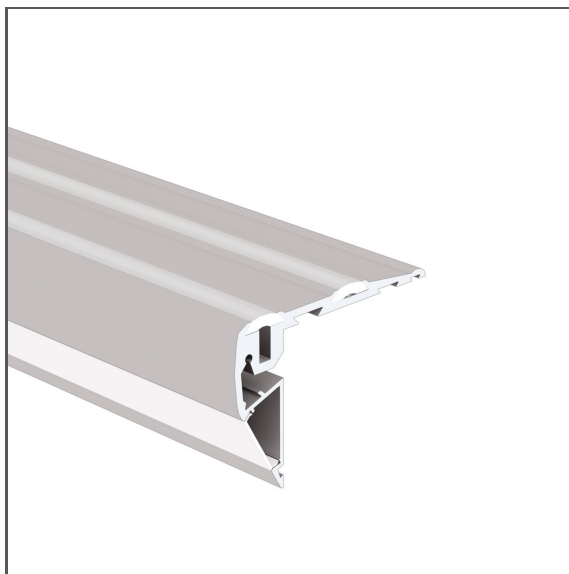

- For installation on the steps
- Conforms to the American ADA norms
- Non-slip elements
- Two lighting options
- High mechanical resistance

APPLICATION

- warning lighting and anti-slip protection on the steps

MOUNTING

- to a step, using properly selected screws

ADDITIONAL INFORMATION

- standard lengths of KLUŚ profiles and covers: 1000 mm (tolerance ± 1.5 mm) and 2005 mm / 3010 mm (tolerance + 5 mm); for selected covers: 6050 mm, 10050 mm (tolerance + 5 mm)
- when choosing a different length of profiles / covers than available in the standard, you should additionally choose the cutting service at KLUŚ

TECHNICAL DRAWING

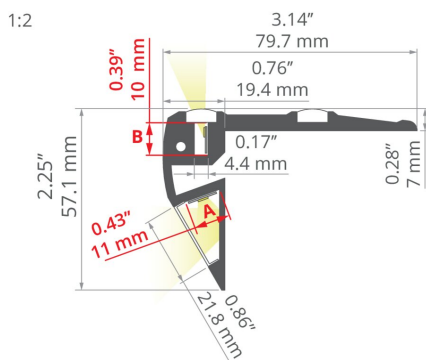

TECHNICAL SPECIFICATIONS

Material	aluminum
Possible fixture IP	20, 67
Possible fixture shapes	linear
Width	79.7 mm
Height	56.1 mm
LED gluing width A	11 mm
LED gluing width B	10 mm
Number of LED strips A (8 mm wide)	1
Possibility of obtaining a line of light	yes
Building type	Commercial, Entertainment/ Arts, HoReCa object
Facility zone	stairs and handrails
The cover is cut to the length of the profile	yes
Wire out back of extrusion	yes

Color	Length	Ref
■ silver anodized	1000 mm	A18038A_1 18038ANODA_1
	2005 mm	A18038A_2 18038ANODA_2
	3010 mm	A18038A_3 18038ANODA_3
■ black anodized	1000 mm	A18038A07_1 18038K7_1
	2005 mm	A18038A07_2 18038K7_2
	3010 mm	A18038A07_3 18038K7_3

Profile STEPUS







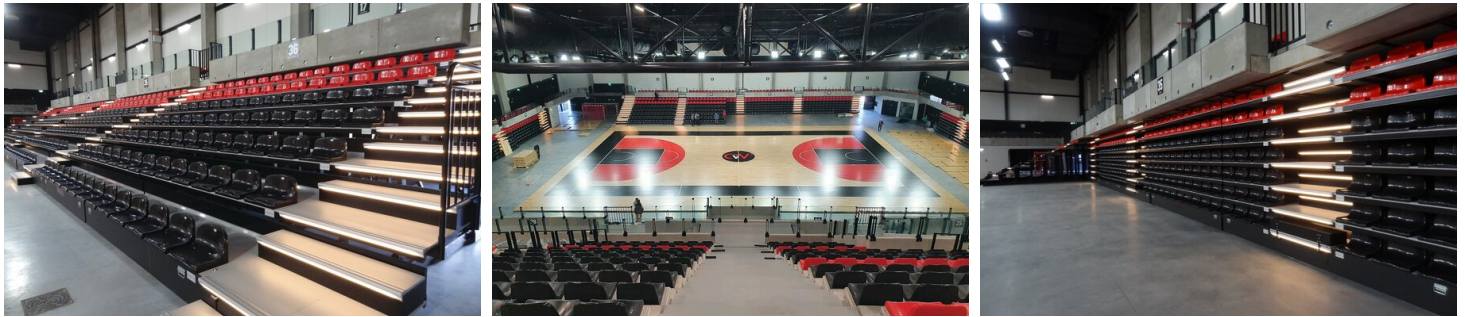

Ref. A18038

Ref. arch 18038







SAMPLE PROJECTS



RELATED ACCESSORIES > RELATED COVERS

NAME	MATERIAL	MATERIAL TRANSMITTANCE	COLOR	REF.
HS-22		73 %	 frosted	B17011M 17011
		94 %	 clear	B17011T 17022
LIGER-22		62 %	 frosted	B17032M 17032V1
				B17032M 17032V1OP
MUN-22		39 %	 black	B17032C 17087
		86 %	 semi-transparent	B17042F 17042

RELATED ACCESSORIES > RELATED END CAPS

NAME	MATERIAL	COLOR	REF.
STEPUS-L		 gray	C28011C02 24229
		 black	C28011C07 24317
STEPUS-P		 gray	C28012C02 24230
		 black	C28012C07 24318

RELATED ACCESSORIES > RELATED LED > HIGH EFFICACY

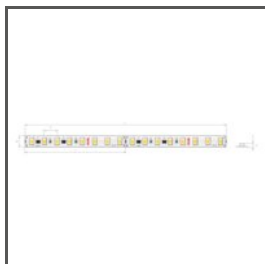

K-HE-0480-HD-24V
K-HEHD-0480-24
Ref. arch K-HE-0480-HD-24V

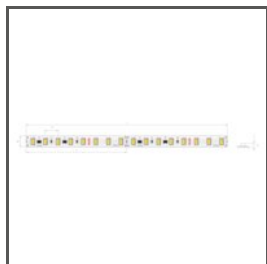

K-HE-0960-HD-24V
K-HEHD-0960-24
Ref. arch K-HE-0960-HD-24V



K-HE-1440-HD-24V
K-HEHD-1440-24
Ref. arch K-HE-1440-HD-24V

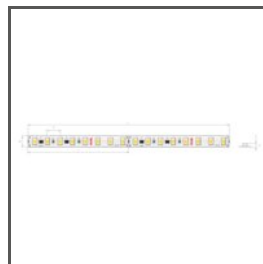

K-HE-1920-HD-24V
K-HEHD-1920-24
Ref. arch K-HE-1920-HD-24V

RELATED ACCESSORIES > RELATED LED > SIDE EMITTING

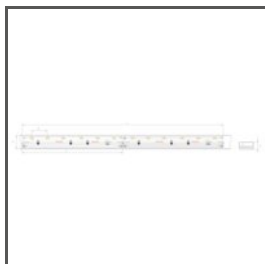

WP-K-SE-1210-8-24V
KWP-SE-1210-24-8
Ref. arch WP-K-SE-1210-8-24V

RELATED ACCESSORIES > OTHER RELATED ACCESSORIES > ADDITIONAL ITEMS



TOOL
C28063
Ref. arch 00023

RELATED ACCESSORIES > OTHER RELATED ACCESSORIES > OTHER



GLAND
6,4x3
C42264C07
Ref. arch 42264

Profile STEPUS

Ref. A18038

Ref. arch 18038

RELATED ACCESSORIES > OTHER RELATED ACCESSORIES > PROFILE MASKING COVERS



MASKING COVER

MP-22

C28261L01_0.25,
C28261L10_0.25,
C28261L07_0.25

Ref. arch 17167, 17167L9010,
17167L9005

RELATED ACCESSORIES > OTHER RELATED ACCESSORIES > SILICONE CORDS



ANTI-SLIP RUBBER STRIP

14

C24537C00

Ref. arch 17001