

# Profile TRIADA

Ref. A04476

Ref. arch B4476

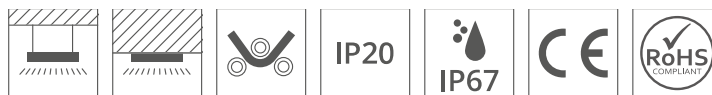
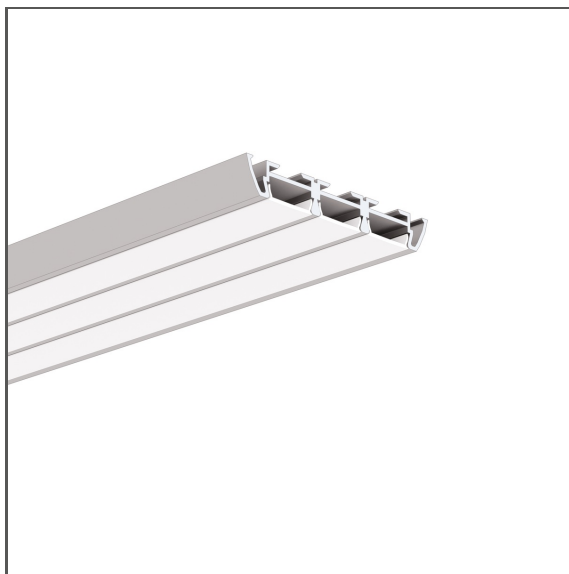

- High lumen output
- Smooth profile walls
- Wide range of accessories
- Small bending radius

## APPLICATION

- main and functional lighting

## MOUNTING

- suspended or to the surface, using a dedicated mounting track, dedicated accessories or properly selected screws
- can be easily connected into runs and systems

## ADDITIONAL INFORMATION

- standard lengths of KLUŚ profiles and covers: 1000 mm (tolerance  $\pm 1.5$  mm) and 2005 mm / 3010 mm (tolerance  $+ 5$  mm); for selected covers: 6050 mm, 10050 mm (tolerance  $+ 5$  mm)
- when choosing a different length of profiles / covers than available in the standard, you should additionally choose the cutting service at KLUŚ

## TECHNICAL DRAWING

1:2

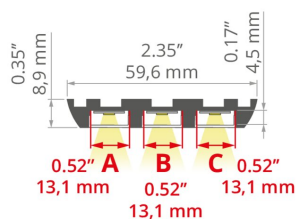

## TECHNICAL SPECIFICATIONS

Material	aluminum
Color	■ silver anodized
Possible fixture IP	20, 67
Possible fixture shapes	linear, polygonal
Profile cross-section	rectangular
Width	59.6 mm
Height	8.9 mm
LED gluing width A	13.1 mm
LED gluing width B	13.1 mm
LED gluing width C	13.1 mm
Number of LED strips A (8 mm wide)	1
Number of LED strips B (8 mm wide)	1
Number of LED strips C (8 mm wide)	1
Possibility of bending	yes
Minimum external radius	200 mm
Minimum internal radius	200 mm
Building type	Commercial, Entertainment/ Arts

Length	Ref
1000 mm	A04476A_1 B4476ANODA_1
2005 mm	A04476A_2 B4476ANODA_2
3010 mm	A04476A_3 B4476ANODA_3

# Profile TRIADA

Ref. A04476

Ref. arch B4476

Facility zone	industrial and technical, shop windows and exhibition, inne
The cover is cut to the length of the profile	yes
Can be easily connected into runs	yes
Wire out back of extrusion	yes

## SAMPLE PROJECTS

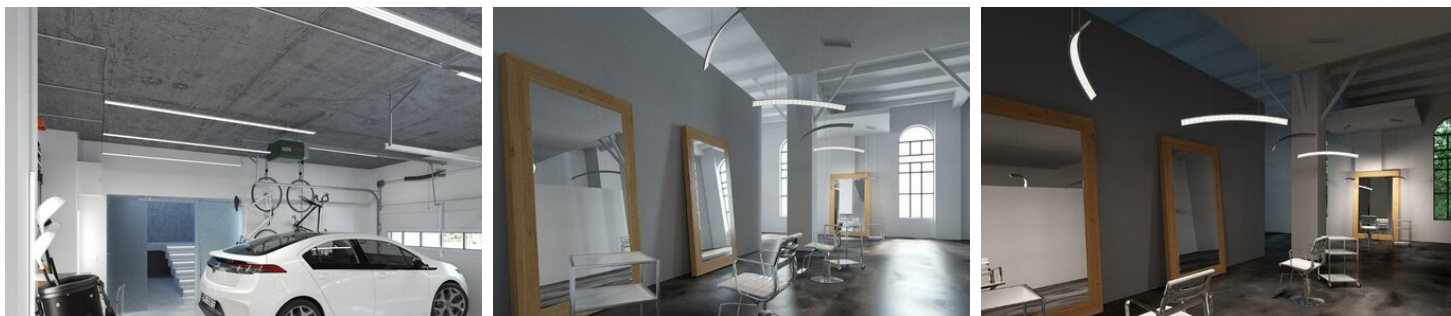

## RELATED PROFILES > MOUNTING TRACKS

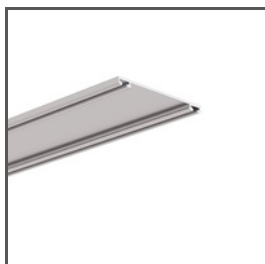



**TETRA-43**  
A04478  
Ref. arch W4476



**TETRA-78**  
A04508  
Ref. arch W4508

## RELATED ACCESSORIES > RELATED COVERS



NAME	MATERIAL	MATERIAL TRANSMITTANCE	COLOR	REF.
KA-PRO-12		74 %	<input type="checkbox"/> frosted	B17066M 17066
		94 %	<input checked="" type="checkbox"/> clear	B17066T 17067
KA-12		69 %	<input type="checkbox"/> frosted	B17078M 17078
		94 %	<input checked="" type="checkbox"/> clear	B17078T 17079
HS-12		73 %	<input type="checkbox"/> frosted	B17201M 00157
		94 %	<input checked="" type="checkbox"/> clear	B17201T 00158

# Profile TRIADA

Ref. A04476

Ref. arch B4476

## RELATED ACCESSORIES > RELATED END CAPS

NAME	MATERIAL	COLOR	REF.
TRIADA	PP	 gray	C24056C02 0090
		 silver	C24056L01 24056

## RELATED ACCESSORIES > RELATED LED

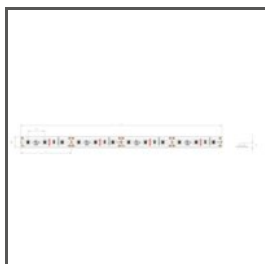

**K-1210-12V**  
K-1210-12  
Ref. arch K-1210-12V



**K-1275-12V**  
K-1275-12  
Ref. arch K-1275-12V

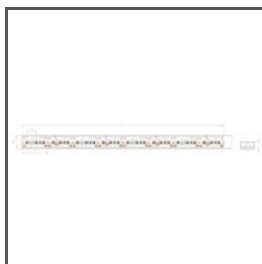

**WP-K-1220-12V**  
KWP-1220-12  
Ref. arch WP-K-1220-12V

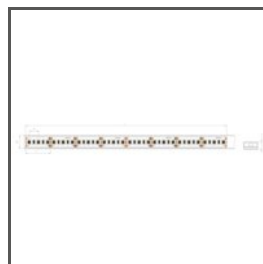

**WP-K-1275-12V**  
KWP-1275-12  
Ref. arch WP-K-1275-12V



**WP-K-1220-IP65-12V**  
\_błąd  
Ref. arch WP-K-1220-IP65-12V

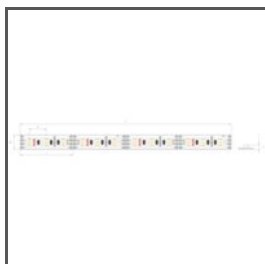

**K-1275-RGB-12V**  
K-RGB-1275-12  
Ref. arch K-1275-RGB-12V

## RELATED ACCESSORIES > RELATED LED > CRI 95+

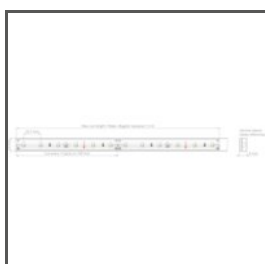

**WP-K-CR-1210-24V**  
KWP-CR-1210-24  
Ref. arch WP-K-CR-1210-24V



**WP-K-CR-1220-24V**  
KWP-CR-1220-24  
Ref. arch WP-K-CR-1220-24V

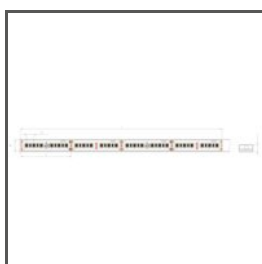

**WP-K-CR-1275-24V**  
KWP-CR-1275-24  
Ref. arch WP-K-CR-1275-24V

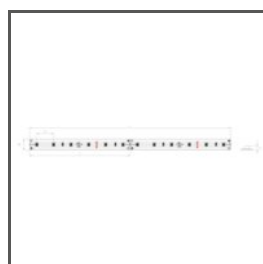

**K-CR-1210-24V**  
K-CR-1210-24  
Ref. arch K-CR-1210-24V



**K-CR-1220-24V**  
K-CR-1220-24  
Ref. arch K-CR-1220-24V

# Profile TRIADA

Ref. A04476

Ref. arch B4476

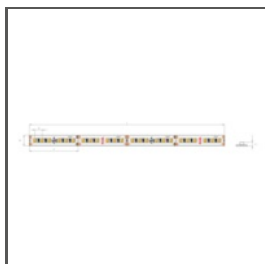

**K-CR-1275-24V**

K-CR-1275-24  
Ref. arch K-CR-1275-24V

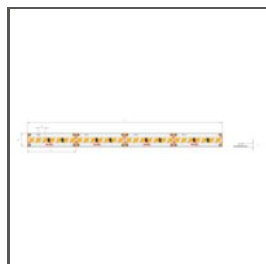

**K-CR-1820-HD-24V**

K-CRHD-1820-24  
Ref. arch K-CR-1820-HD-24V

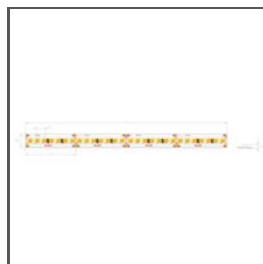

**K-CR-1910-HD-24V**

K-CRHD-1910-24  
Ref. arch K-CR-1910-HD-24V

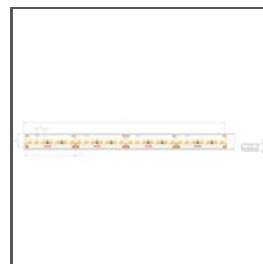

**WP-K-CR-1820-HD-24V**

WPKCR1820HD24  
Ref. arch WPKCR1820HD24V



**WP-K-CR-1910-HD-24V**

KWP-CRHD-1910-24  
Ref. arch WPK-CR-1910-HD-24V

## RELATED ACCESSORIES > RELATED LED > DIM TO WARM



**K-27/50-1440-24V**

K-27/50-1440-24

## RELATED ACCESSORIES > RELATED LED > HIGH EFFICACY

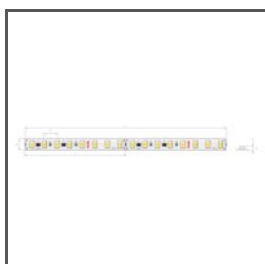

**K-HE-0480-HD-24V**

K-HEHD-0480-24  
Ref. arch K-HE-0480-HD-24V

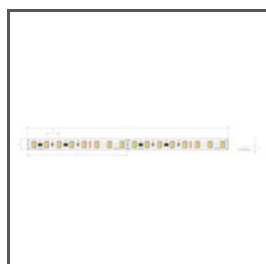

**K-HE-0960-HD-24V**

K-HEHD-0960-24  
Ref. arch K-HE-0960-HD-24V

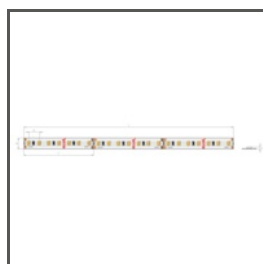

**K-HE-1440-HD-24V**

K-HEHD-1440-24  
Ref. arch K-HE-1440-HD-24V

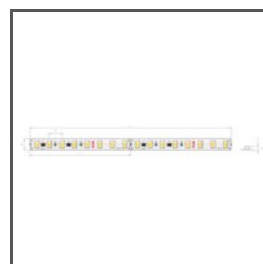

**K-HE-1920-HD-24V**

K-HEHD-1920-24  
Ref. arch K-HE-1920-HD-24V

## RELATED ACCESSORIES > RELATED LED > RGB / RGB-W / RGB-CTT



**K-1530-RGB+W-24V**

K-RGBW-1530-24  
Ref. arch K-1530-RGB+W-24V

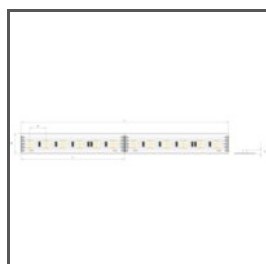

**K-1920-120-RGB-24V**

K-RGB-1920-120-24  
Ref. arch K-1920-120-RGB-24V

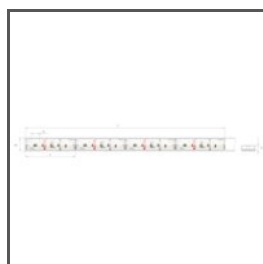

**WP-K-1920-120-RGB-24V**

KWP-1920-120-RGB-24  
Ref. arch WP-K-1920-120-RGB-24V

RELATED ACCESSORIES > RELATED LED > WHITE MONO



**WP-K-1910-HD-IP65-24V**  
KWP-GHD-1910-24  
Ref. arch WP-K-1910HDIP6524V



**K-2400-24**  
K-2400-24

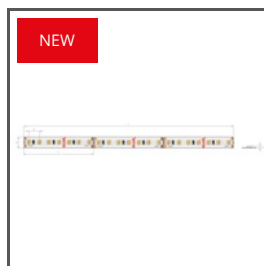

**K-1440-24V**  
K-1440-24  
Ref. arch K-1440-24V



**K-0960-24V**  
K-0960-24  
Ref. arch K-0960-24V

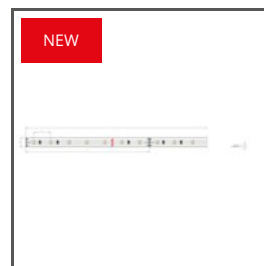

**K-0480-24V**  
K-0480-24  
Ref. arch K-0480-24V



**K-0530-HD-24V**  
K-HD-0530-24  
Ref. arch K-0530-HD-24V



**WP-K-1220-IP65-24V**  
KWP-1220-IP65-24  
Ref. arch WP-K-1220-IP65-24V



**WP-K-1640-HD-IP65-24V**  
KWP-GHD-1640-24  
Ref. arch WP-K-1640-HD-IP65-24V



**WP-K-1440-24V**  
KWP-1440-24  
Ref. arch WP-K-1440-24V



**WP-K-0480-24V**  
KWP-0480-24  
Ref. arch WP-K-0480-24V



**WP-K-0960-24V**  
KWP-0960-24  
Ref. arch WP-K-0960-24V

RELATED ACCESSORIES > OTHER RELATED ACCESSORIES > CONDUCTIVE FASTENERS AND HEADS FOR PROFILES



FASTENER  
**PUSZ-LIN-ZD**  
C28164N00, C28164L10,  
C28164L07  
Ref. arch 42279, 42279L9010,  
42279L9005



FASTENER  
**PUSZ-PRET-ZD**  
C28167N00, C28167L10,  
C28167L07  
Ref. arch 42282, 42282L9010,  
42282L9005

RELATED ACCESSORIES > OTHER RELATED ACCESSORIES > CONNECTORS



CONNECTOR  
**ZD-PION-90**  
C28244N00  
Ref. arch 43504



CONNECTOR  
**ZD-PION-135**  
C28245N00  
Ref. arch 43505

RELATED ACCESSORIES > OTHER RELATED ACCESSORIES > FASTENERS AND HEADS FOR PROFILES



FASTENER  
**UCHO-ZD**  
C28193N00  
Ref. arch 42513

RELATED ACCESSORIES > OTHER RELATED ACCESSORIES > OTHER



GLAND  
**6x1,2**  
C24517C07  
Ref. arch 00802

RELATED ACCESSORIES > OTHER RELATED ACCESSORIES > SECURITY AND BLOCKS



BLOCK  
**ZD**  
C28195N00  
Ref. arch 42521

# Profile TRIADA

Ref. A04476

Ref. arch B4476

## RELATED ACCESSORIES > OTHER RELATED ACCESSORIES > SURFACE SPRINGS

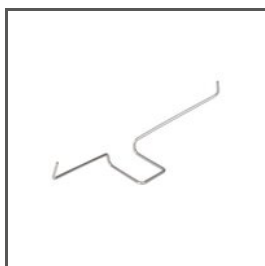

SPRING

**TR**

C24502N00

Ref. arch 00801

## RELATED ACCESSORIES > OTHER RELATED ACCESSORIES > SUSPENSION AND MOUNTING SETS



FASTENER SET

**RG-1**

C28230P00, C28230P01,  
C28230L10, C28230L07

Ref. arch 42647Ni, 42647GSS,  
42647L9010, 42647L9005